

## Ordering tool HS comfort surface mounted arrangement / covered arrangement

The following order guide is intended to simplify the configuration and ordering of a HS comfort drive system.

**Notice:** The ordering tool does not replace any technical planning.  
The associated installation and commissioning documentation must always be taken into account.

**Notice:** This document may not be displayed correctly in your browser.  
Please open the document locally on your computer using Adobe Reader.

Building project : \_\_\_\_\_  
 Contact Person : \_\_\_\_\_  
 Name : \_\_\_\_\_ Street : \_\_\_\_\_  
 Tel no : \_\_\_\_\_ City : \_\_\_\_\_  
 Note : \_\_\_\_\_

### Version

Profile name : \_\_\_\_\_

surface mounted arrangement

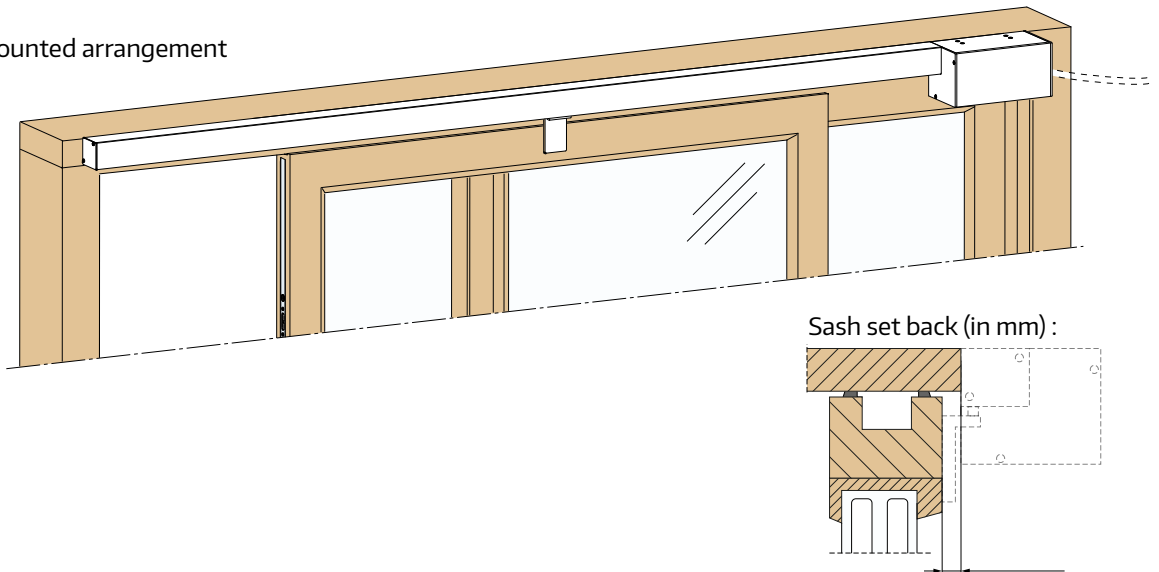

covered arrangement

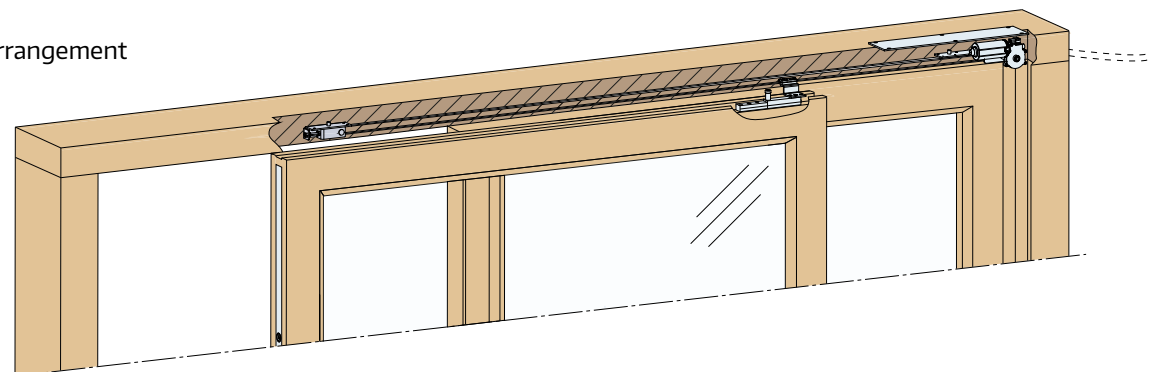

**Type**

Lift and slide system

Lift and slide system

Slide system

lift electrically;  
Slide electrically

lift manually;  
slide electrically

slide electrically

**Scheme**

Scheme A, fixed sash left

Schema A, fixed sash right

Scheme C

## Espag

bolt espag

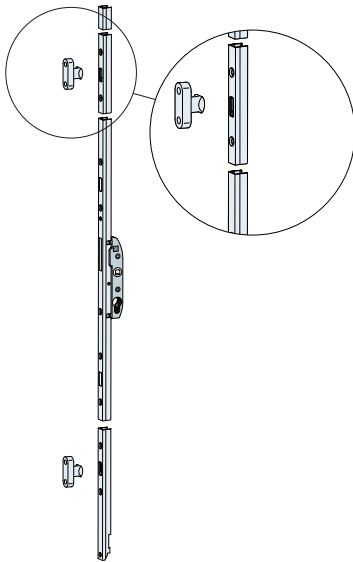

inviso espag

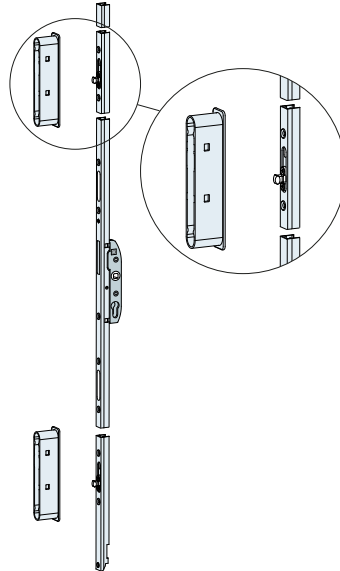

hook espag

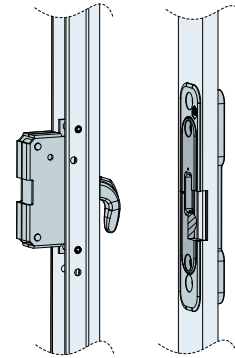

### notice:

- An external power supply unit is required (dimensions 30 x 24 x 305 mm), which must be accommodated on site. Alternatively, a top-hat rail power supply unit can be used.
- The length of the cable from the power supply to the slide drive can be extended up to a maximum of 30 m.
- The 24 V power connection is located on the side where the drive unit sits.
- The end position in the OPEN position is 130 mm before the mechanical end position, or 10 mm with reduced stop range.
- The profile-dependent hardware components (threshold, runner, connecting rod, locking bolt, strikers, shims for lift drive) must be ordered separately.
- Concealed version only for timber from IV 68 and guide rail 6

## Element dimensions (in mm)

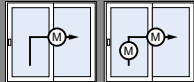
range of application							
	slide electrically 			manuel / electrically lift slide electrically 			
max. outer frame width	6500 mm			6500 mm			
ratio Sash height / Sash width	2:1			2:1			
max. Sash weight	200 kg	300 kg	440 kg ***	270 kg	400 kg	330 kg	440 kg***
HAUTAU-Fitting	S 200	S 300	*	HS 270 slim	HS 400 slim	HS 330	HS 440
back set	27,5 mm	27,5 mm		27,5 mm	27,5 mm	27,5 mm	27,5 mm
min. Sash width	650 mm	720 mm		650 mm	1220 mm	720 mm	1310 mm
max. Sash width	2360 mm	3235 mm		2360 mm		3235 mm	
min. Sash height	650 mm			1900 mm			
max. Sash height	2700 mm			2700 mm		2700 mm (3300 mm**)	

\* external fitting, for details see fitting manufacturer

\*\* with gear extension

\*\*\* additional anti-trap protection is required for weights >330 kg.

1. Sash weight : \_\_\_\_\_ kg
2. Outer frame width : \_\_\_\_\_ mm
3. Sash width : \_\_\_\_\_ mm
4. Sash height : \_\_\_\_\_ mm

kg

## Segmentation

symmetrical

asymmetrical

## Operation

### Control keypad

Keypad with display for the opening and closing process and for signalling faults of faults. Plastic housing for mounting on the frame with the dimensions 40 x 138 x 18 (W x H x D in mm).  
Incl. 10 m supply cable.

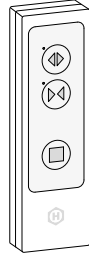

### Push-button box

Push-button box for connecting on site toggle push-button incl. 10 m connection cable 3 x 0.25 mm<sup>2</sup>.

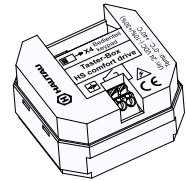

## Accessories

### WLAN-Box / Config Tool

yes  
no

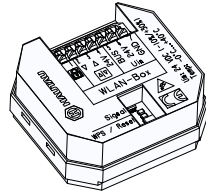

The WLAN box offers the possibility to operate and configure products with a HAUTAU interface via smartphone or tablet. The connection is made directly to the WLAN box or via an on-site WLAN router with prior WPS registration.

### LAN-Module (Optional)

yes  
no

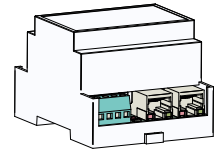

Connection to established bus systems via LAN Data transmission Range of functions depends on the bus system in use, the system integration of the products and the use of compatible LAN gateways for data exchange with the HAUTAU LAN module.

### Key push-button

yes  
no

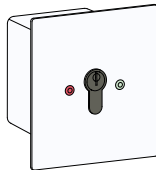

Optional flush-mounted key switch for manual operation. Suitable for outdoor installation. Supplied without profile half cylinder.

### Installation aid

#### Drilling jig for surface-mounted variant

yes  
no

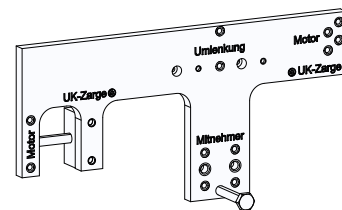

## Power supply

### Power supply unit (supported arrangement)

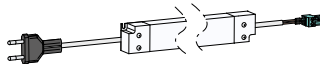

### Power supply unit (covered arrangement)

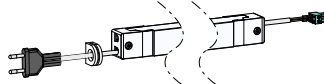

### Top hat rail power supply unit w. connection clamps

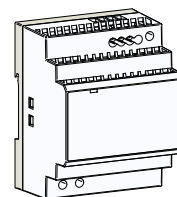

## Colours

### Slide drive

blank (for coating)

white (RAL 9016)

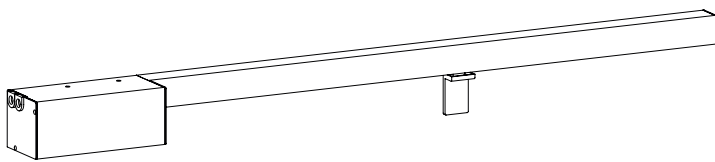

silver (RAL 9006)

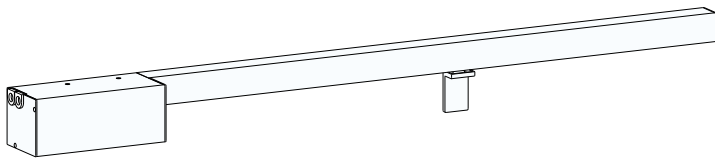

black (RAL 9005)

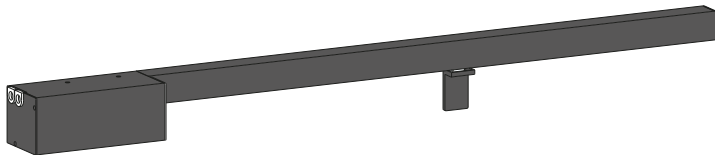

### Cover manual emergency release

blank (for coating)

white



black



F1

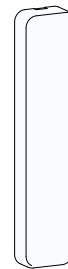

F9

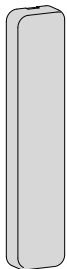

### Control keypad

white (RAL 9016)

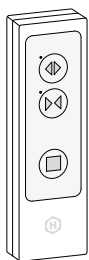

silver (RAL 9006)

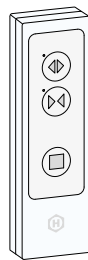

black (RAL 9005)

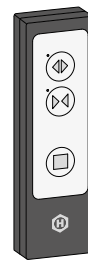

## Safety elements

Class III\* (without additional safety elements)

---

Class IV\*

Infrared light curtain (inside)

Infrared light curtain (outside)

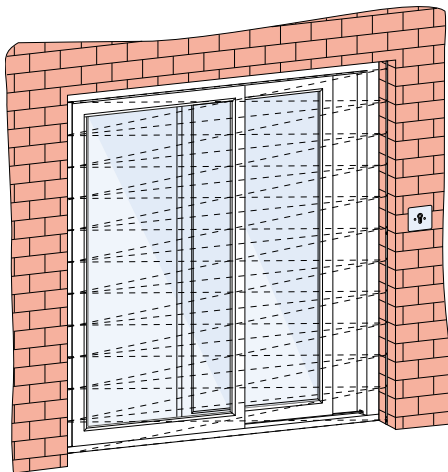

Infrared motion detector (inside)

Infrared motion detector (outside)

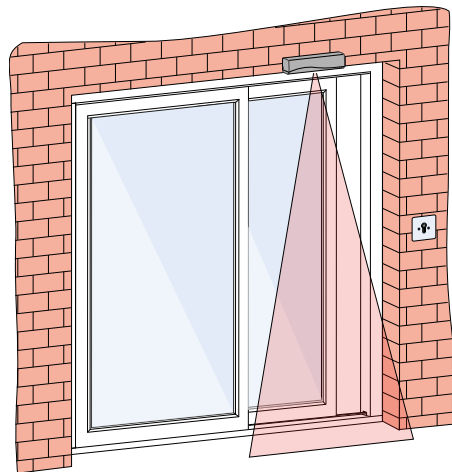

Dead man's operation

\*) According to Machinery Directive 2006/42/EG

## Ordering tool HS comfort surface mounted arrangement / covered arrangement

Customer information	
Building project :	
Name :	
Street :	
City, Postal Code :	
Telefon :	

Sash	
Profile :	
Sash set back :	
Variante :	
Type :	
Scheme :	
Espag :	
Frame width :	
Sash dimensions :	x
Sash weight :	
Seperation :	

Colours	
Slide drive :	
Control Keypad :	
Cover manual emergency release :	

Protection	
Protection class :	
Inside :	
Outside :	

Accessories	
Control Keypad :	
Key push-button :	
Wlan-Box / Config tool :	
LAN-Module :	
Power supply :	
Push-button box :	
Drilling jig (surfaced mounted) :	

Additional information	
Contact Person :	
Note :	